



Your Family Health History



A DNA Day Activity



The Pedigree

- A *pedigree* is a drawing of a family tree
- The pedigree is used by genetic counselors and other medical professionals to assess families and try to spot patterns or indications which may be helpful in diagnosing or managing an individual's health
- Pedigree uses specific symbols and “rules” so no matter who draws it, anyone can read and understand it

EXAMPLE

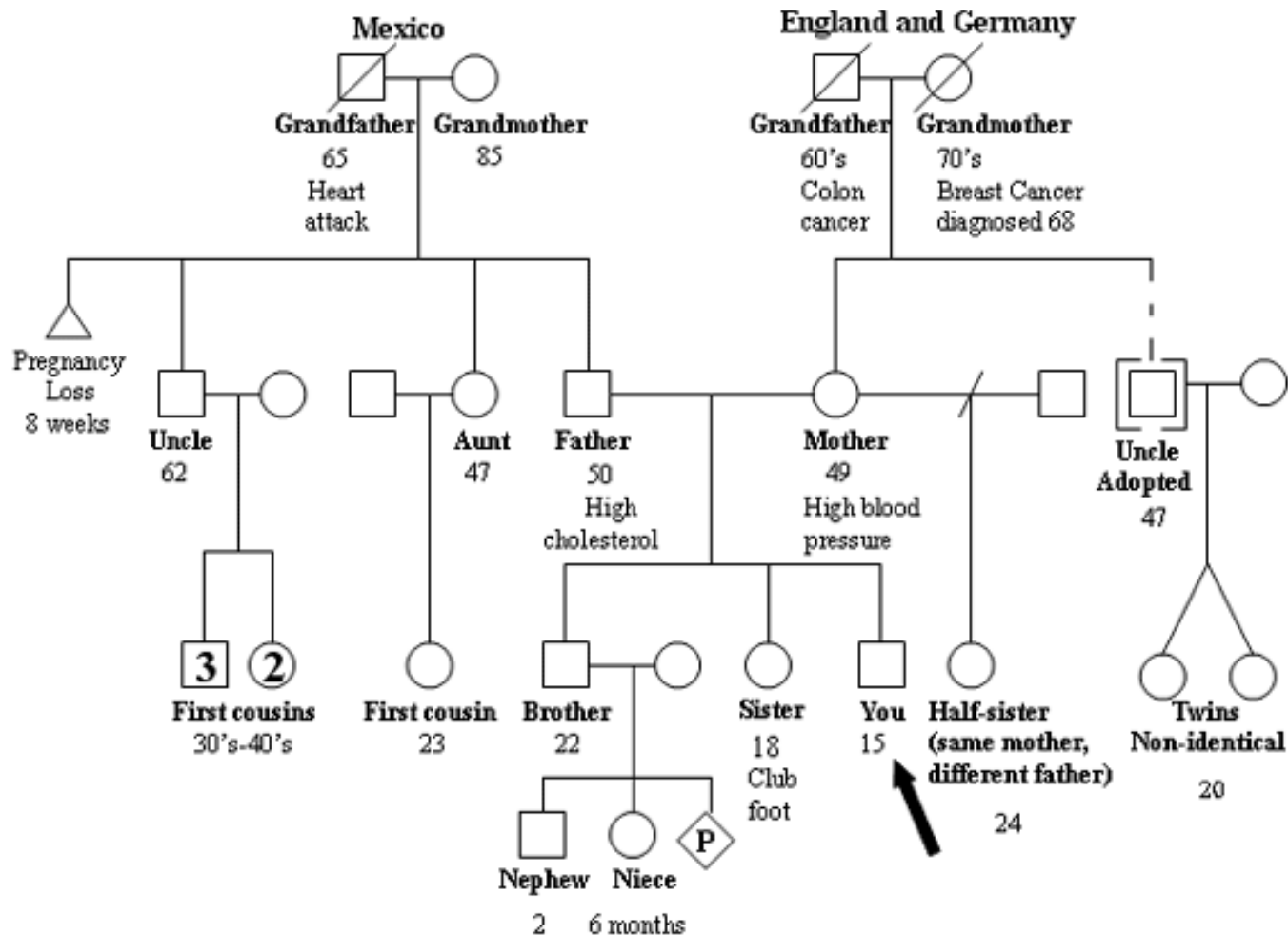

Creating Your Pedigree: 3 Steps

- First step: talk to your family!
 - Ask questions, write down what they say, collect all information possible
- Draw a basic outline of your family tree using pedigree symbols
- Record the information you gathered on the drawing to complete the pedigree

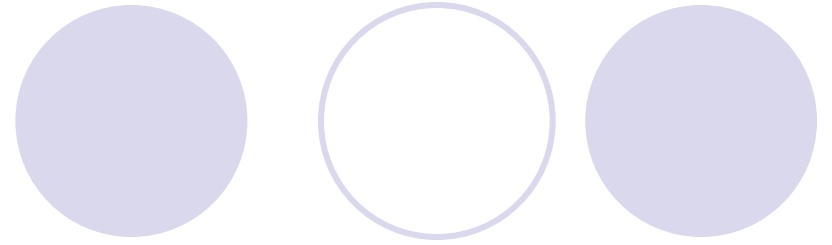
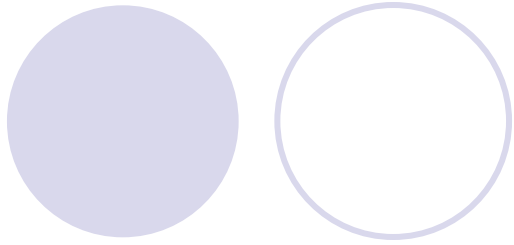

Step 1: Your Family's Information



Gathering Information

- Write a list of all your family members, including:
 - Parents
 - Brothers and sisters (include half-siblings)
 - Children
 - Grandparents
 - Aunts and uncles
 - Cousins
 - Nieces and nephews

DON'T FORGET YOURSELF!



Gathering Information

- Next to each family member's name, write down everything you know about their health and medical history
- If you can later, ask family members questions and find out as much information as possible
- Information about health is a sensitive topic, so if you do talk to family members, make sure to be respectful of this
- If you are adopted, you can collect information on either or both your adopted and birth families
 - A pedigree of your adopted family will not give you much information about your own genetic make-up, but would tell you a lot about the family you are part of.
 - A pedigree of your birth family will tell you more about your personal genetic history, but it may be more difficult to learn details



Information to Include

- Age or date of birth (or best guess, e.g. 40's)
- Date of death for family members who have passed away
- Height and weight (optional)
- For those with medical problems, write down things like if they smoked, diet or exercise habits, etc.
- For those with medical conditions, write down how old the person was when they were diagnosed
- Where each side of your family comes from originally (e.g. England, Mexico, India, etc.)
- Medical conditions such as:
 - Cancer
 - Heart disease
 - Diabetes
 - Asthma
 - Mental illness
 - High blood pressure
 - Stroke
 - Kidney disease
 - Birth defects (e.g. spina bifida, cleft lip, heart defect)
 - Learning problems or mental retardation
 - Vision or hearing loss at a young age
 - Known genetic conditions, like cystic fibrosis or sickle cell disease

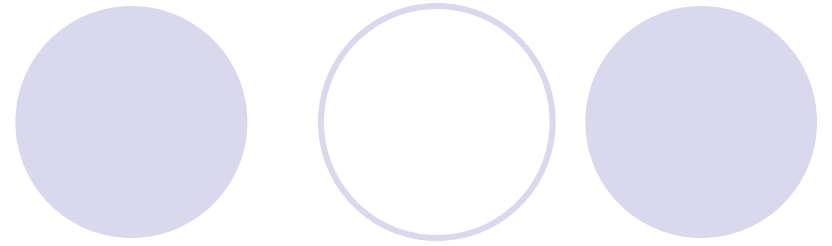
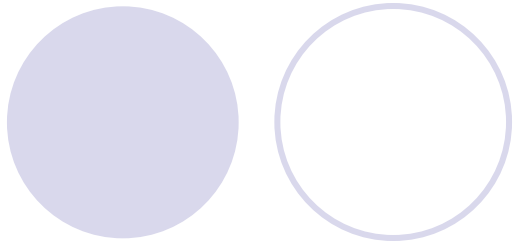

Step 2: Drawing Your Family Tree

Symbols Used in Drawing



Male

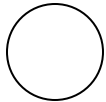

Female

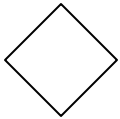

Gender unknown

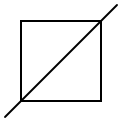

A diagonal line through a symbol means a person is deceased

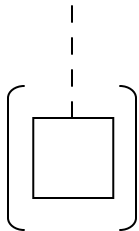

Brackets around a symbol and a dashed line leading to it means a person is adopted



P stands for pregnancy – mother carrying a male, female, or unknown gender

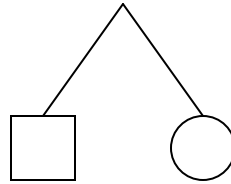

Non-identical twins

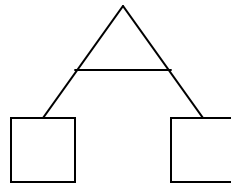

Identical twins

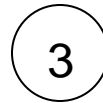

To save space, you can sometimes write a number inside a symbol instead of drawing each symbol (e.g. three sisters)



Pregnancy loss (i.e. miscarriage, stillbirth, elective abortion)

Ready to Draw!

- First, start with yourself!
- Place yourself towards the bottom or middle of the center of the page, because older generations will go above you
- But leave space underneath your symbol for your information
 - Date of birth, any medical conditions, height and weight (optional)

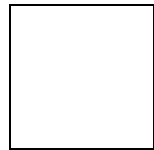

Squares represent males

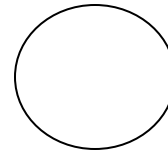

Circles represent females

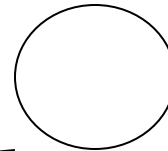
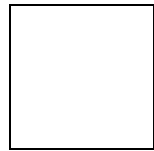

An arrow next to you represents that YOU are the person who called attention to this family

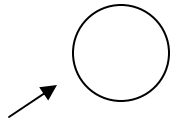

Jane Jones
b. 4/25/1990
asthma

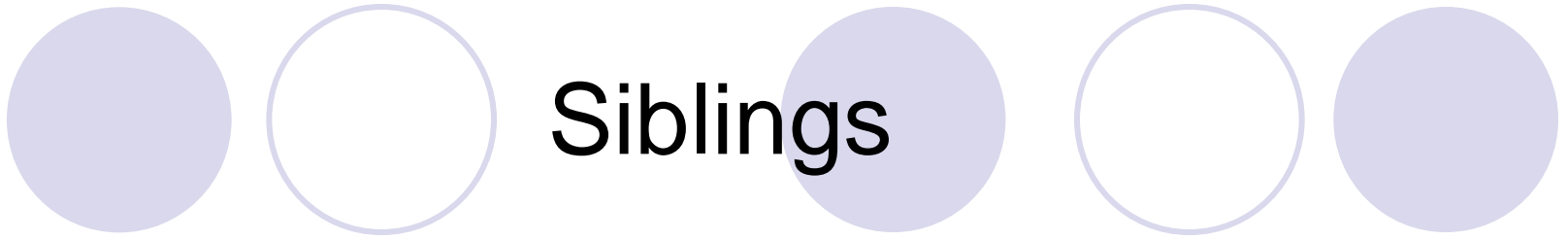

- Draw your brothers and sisters next to yourself
- Older siblings go on your left, younger siblings on your right
- Then draw vertical lines up from each sibling and connect the vertical lines with a horizontal line. This represents a *sibship*. Half-siblings should be added later.

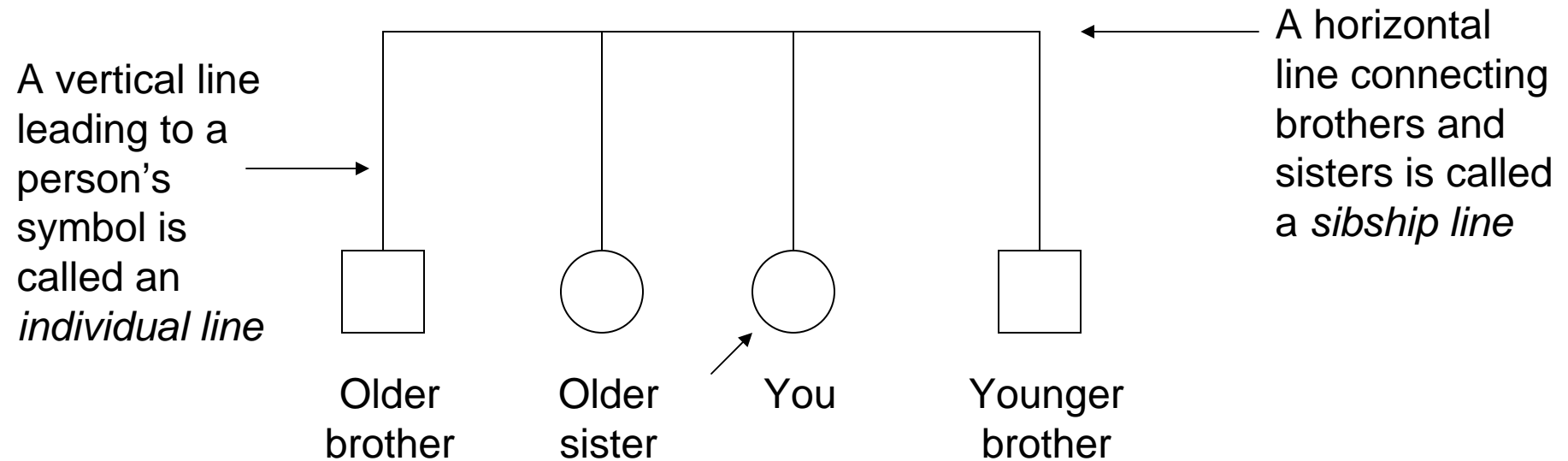

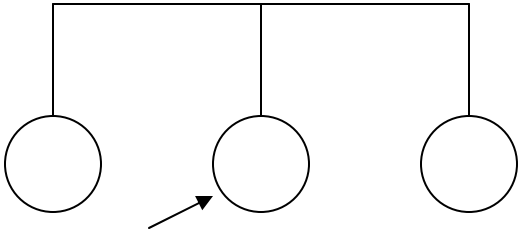

Jane Jones
b. 4/25/1990
asthma

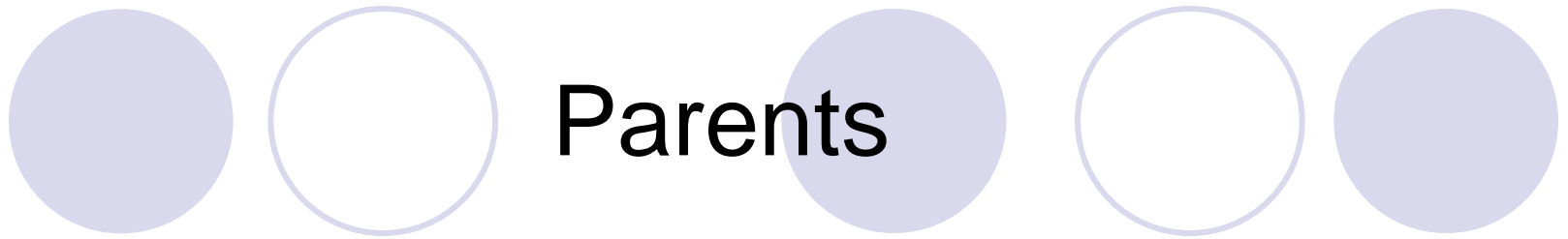

Parents

- Draw your parents above yourself
- Draw a horizontal line connecting your parents. Then draw a vertical line from the horizontal line to your symbol (if only child) or the sibship line.
- The horizontal line is a *relationship* line. If your biological parents are divorced or not together, draw a diagonal line through the horizontal line. If either of your parents have children with a different partner, draw a second relationship line to the other partner. Any half-siblings from this relationship should have a vertical line stemming from the new relationship line.

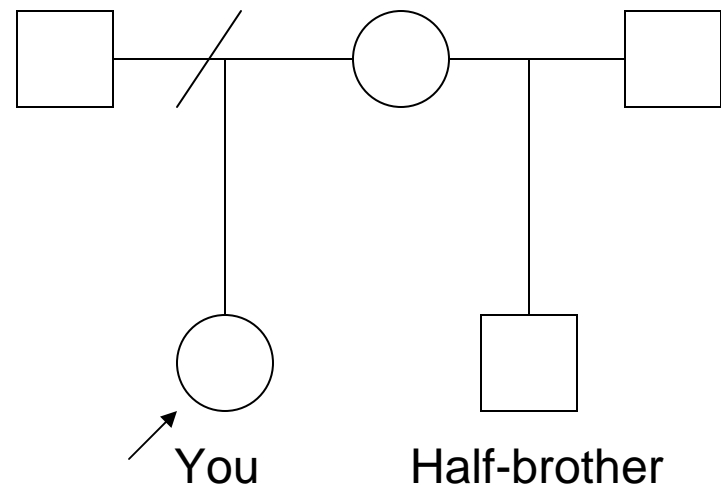
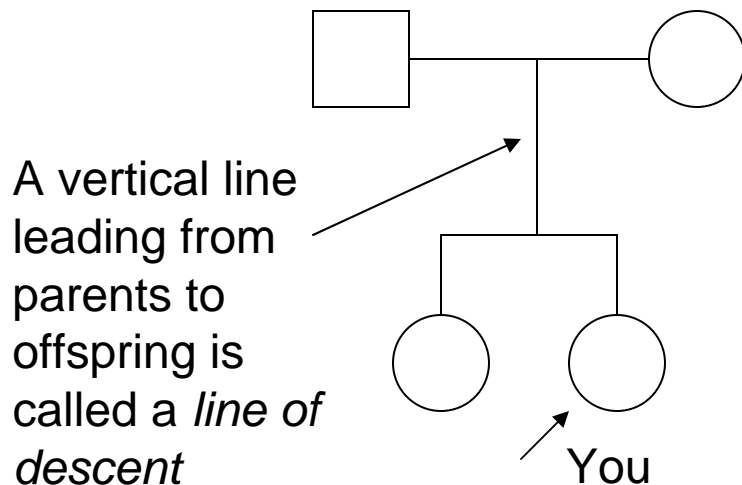

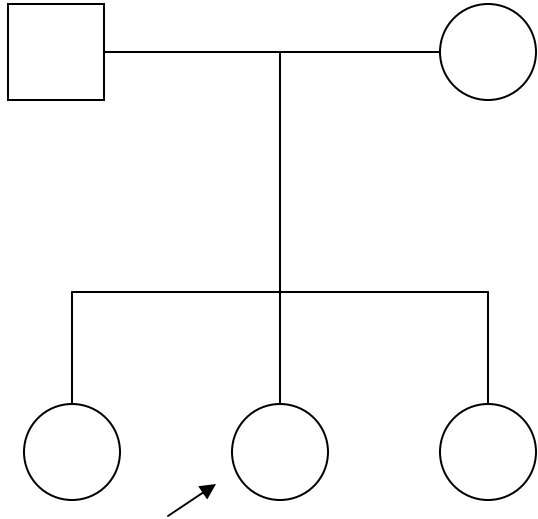

Jane Jones
b. 4/25/1990
asthma

Aunts, Uncles, Cousins, Nieces & Nephews

- Your parents' siblings (your aunts and uncles) are drawn next to them and connected with a sibship line.
- It's okay if you have to draw them out of order by age, but do your best!
- In order to save space, you may choose not to include the spouses of your parents' brothers and sisters. When drawing cousins, connect their line of descent directly to their parent or to their parents' relationship line. Same concept when drawing the children of your siblings (nieces and nephews).

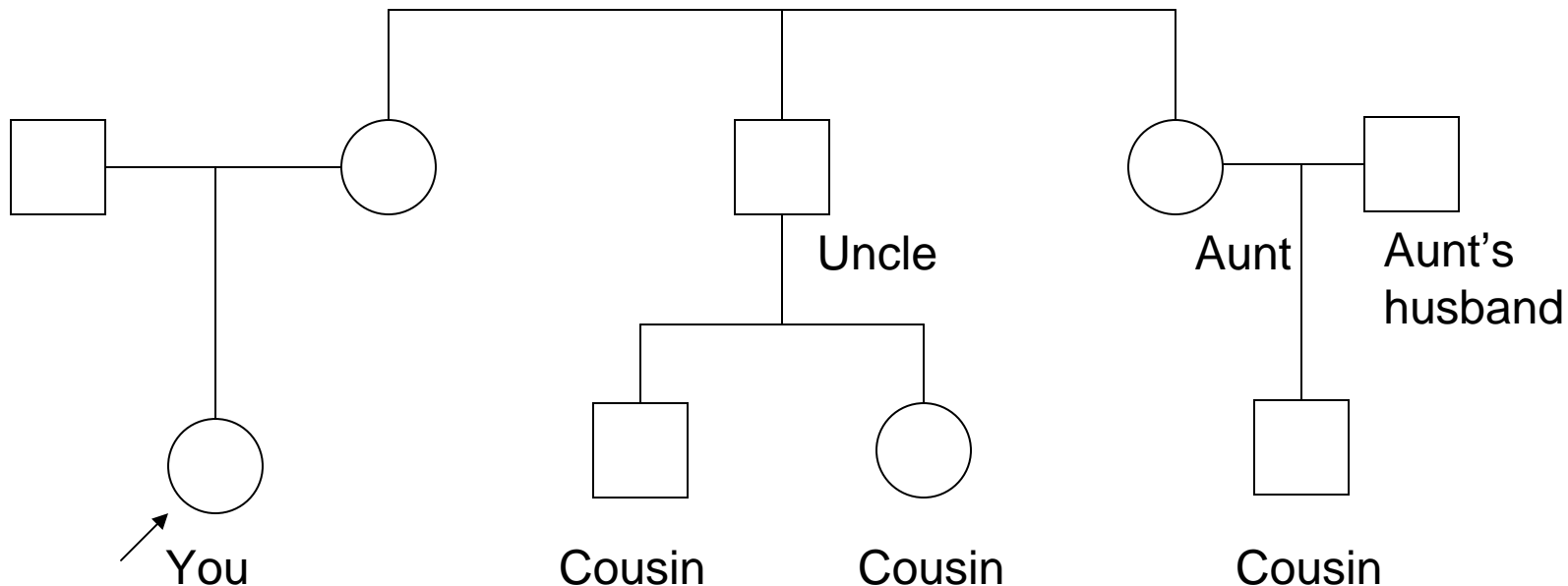

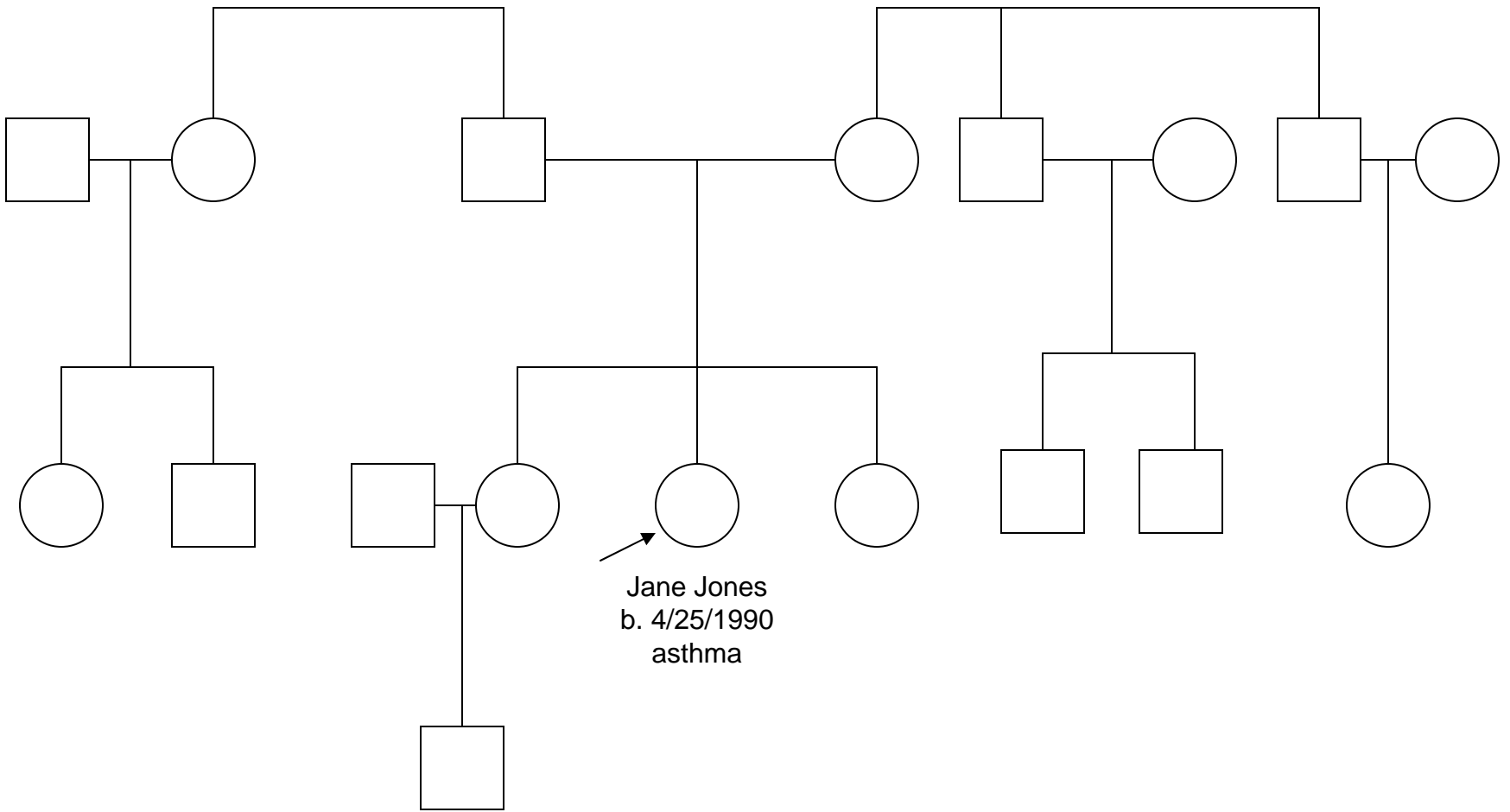

Grandparents

- Draw your maternal grandparents above your mother, or your mother's sibship line. Connect them with a relationship line (if applicable) and draw a line of descent to your mother or mother's sibship line
- Draw your paternal grandparents above your father, or your father's sibship line. Connect them with a relationship line (if applicable) and draw a line of descent to your father or father's sibship line

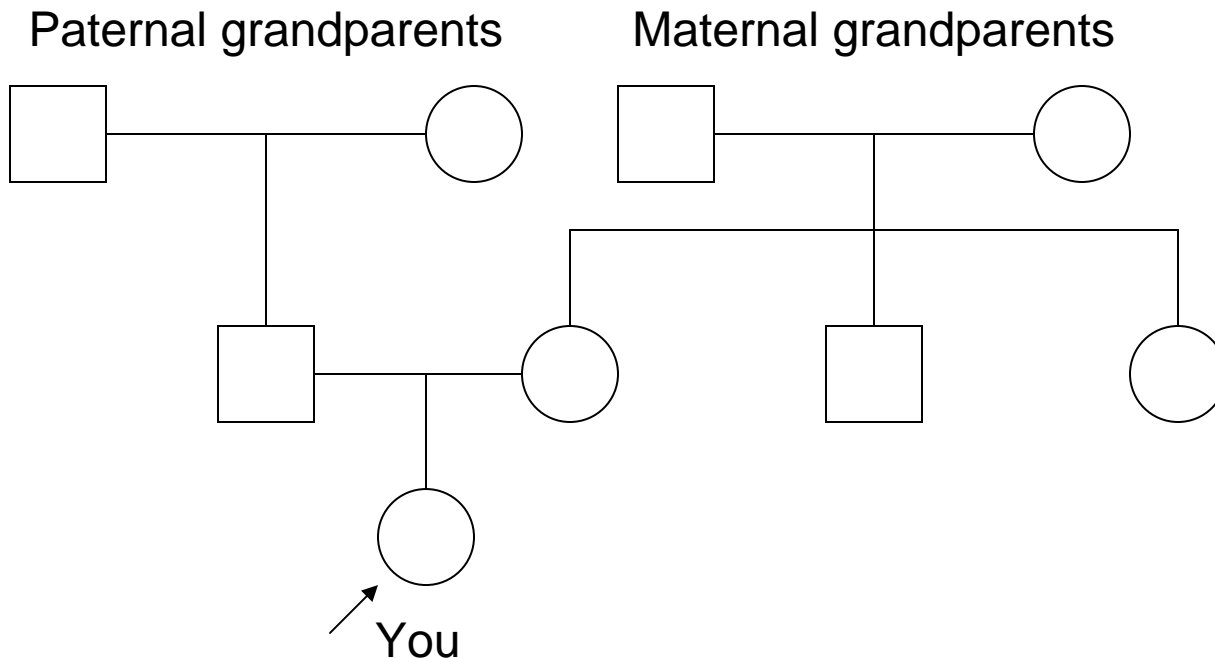

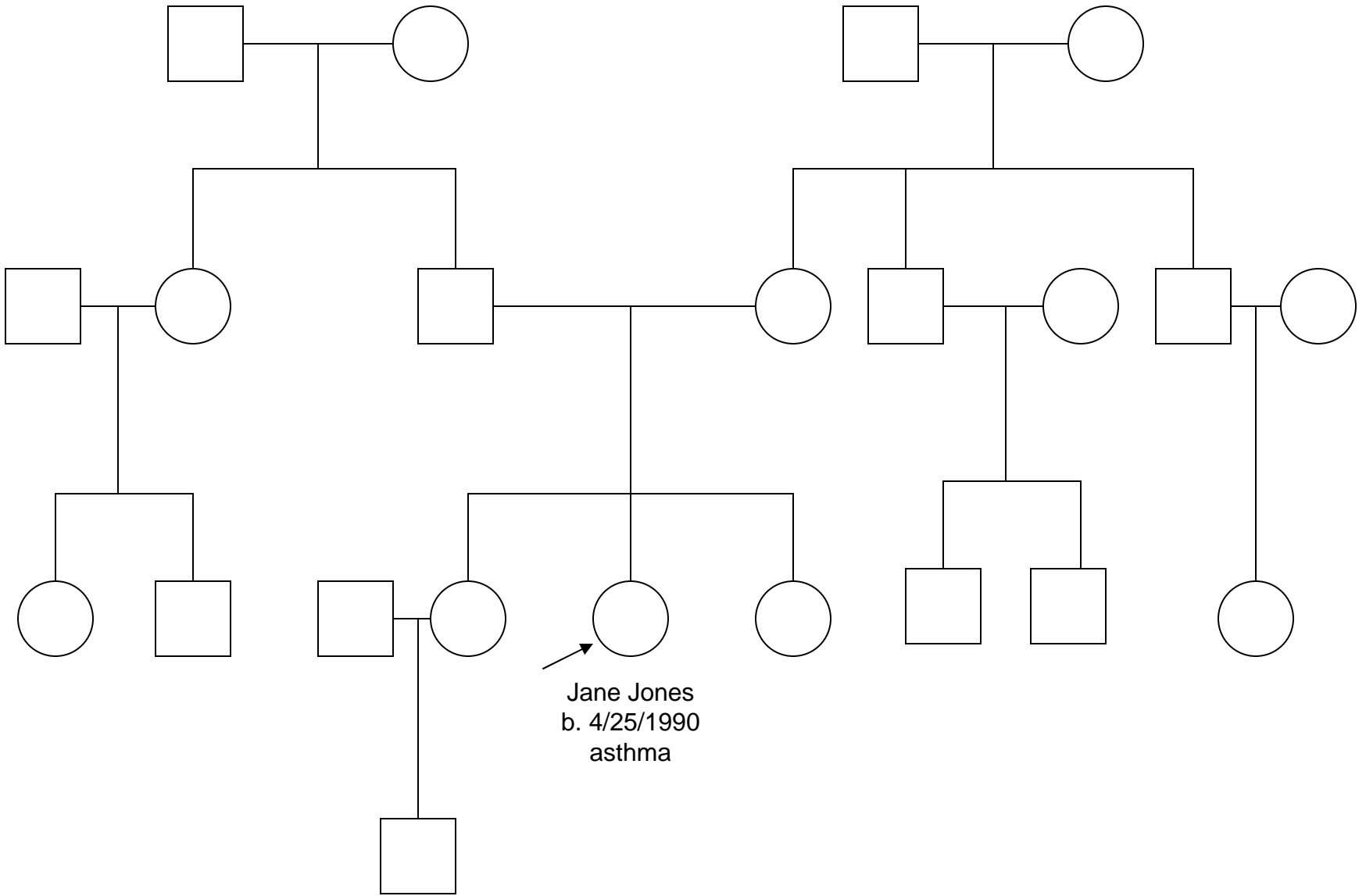

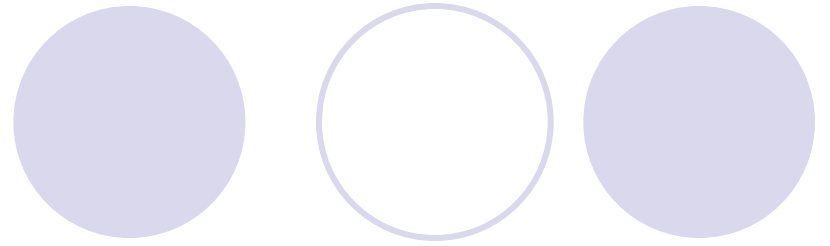
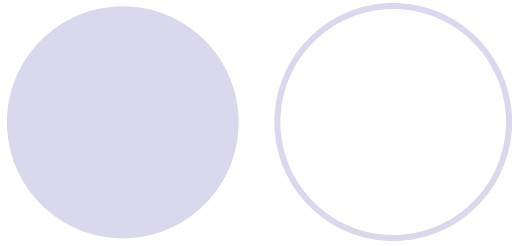

Step 3: Put it all together and what do you get . . .

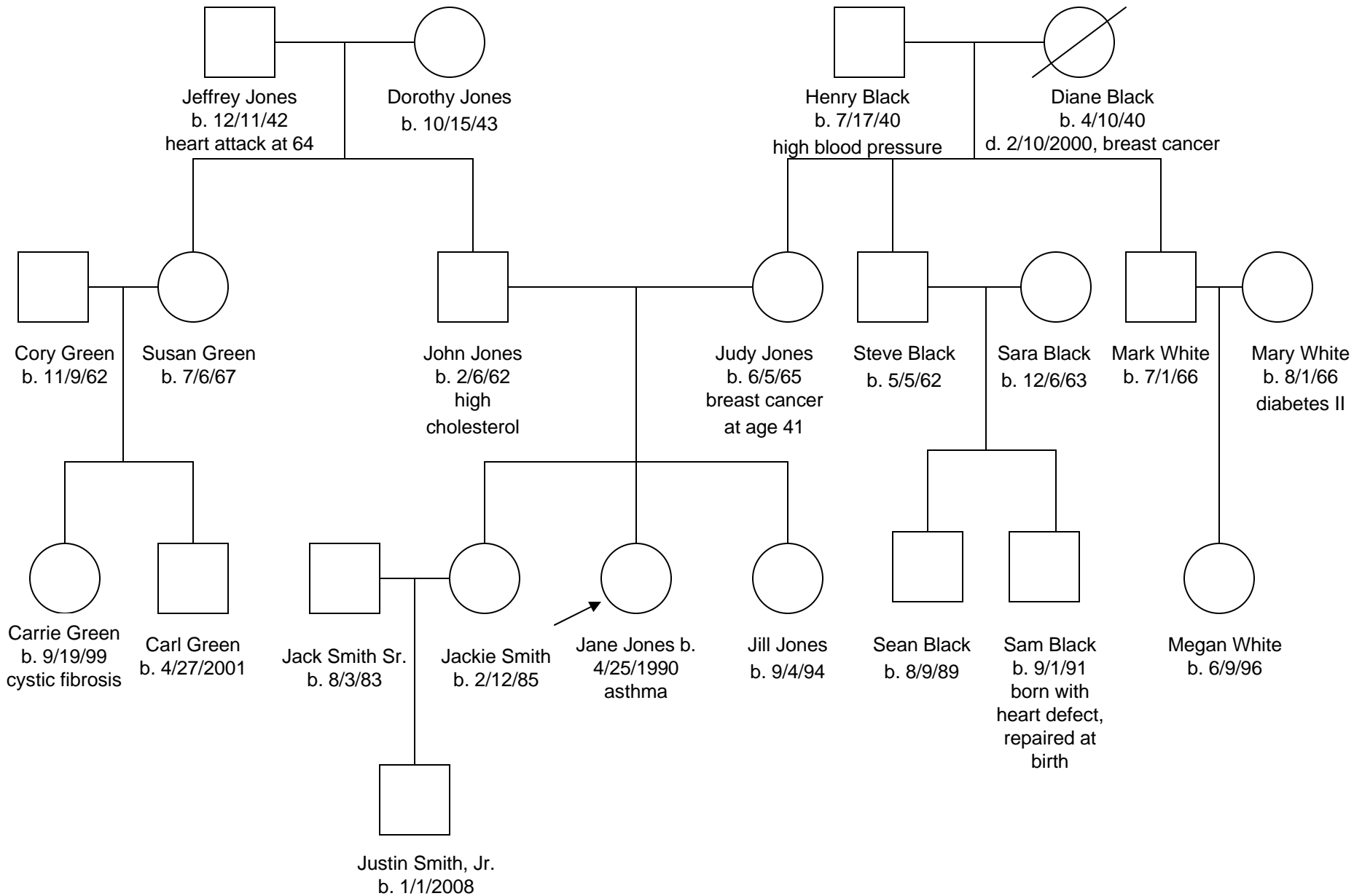

What to Do with Your Pedigree

- Take it home! Clean it up, add to it, ask your parents about corrections – have a complete and accurate pedigree on hand
- Store your pedigree in a safe place. Every couple of years, take it out and update it as necessary.
- Give a copy to your physician. It might come in handy to have this information in your medical chart someday in the future.
- If there is something on your pedigree which concerns you, take it to a medical professional or genetic specialist for their assessment.



Discussion

- Why would a pedigree be useful to a doctor or genetic counselor?
- What can be determined from looking at our example pedigree? If you were a doctor or genetic counselor, what would you discuss with our example family?
- Should all doctors be required to ask their patients about their family health history? Why or why not?